



testo 6447 compressed air meter

Instruction manual



Contents

1	GENERAL INFORMATION	5
1.1	Incoming goods inspection, transportation and storage	5
2	SAFETY PRECAUTIONS	6
2.1	Intended use	6
2.2	Installation, commissioning and operation	7
2.3	Exclusion of liability	8
3	DESIGN AND FUNCTION	9
3.1	Electric sensor unit interchangeable fitting	10
3.2	Interchangeable fitting with Compac flange	11
3.3	Compac welding neck flange (V flange) steel	12
3.4	Dummy plug included as standard	13
3.5	Measuring station	14
3.6	ISO calibration points	14
4	TECHNICAL DATA	15
4.1	Thermal mass flow sensor	15
4.2	Accessories	16
4.2.1	Connecting cable with electric isolation	16
4.2.2	Replacement sensor	16
4.2.3	Calibration options	16
5	INSTALLATION	17
5.1	Determining the place of installation	17
5.2	Length measurements of the compressed air meter	18
5.3	Installation position	19
5.4	Required measuring section	20
5.5	Direction of flow	20
5.6	Installation of the compressed air meter	21
5.6.1	Installation of the measuring station	21
5.6.2	Installing the sensor in the measuring station	22
5.7	Sensor replacement	23
5.8	Electrical connection	24
5.8.1	4-wire pin assignment	24
5.8.2	5-wire pin assignment (accessory)	25

Contents

6	OPERATION	26
	Thermal mass flow sensor.....	26
6.1	Controls and indicators	26
6.2	Types of operation.....	28
6.2.1	Run mode	28
6.2.2	Display mode	28
7	MENU	29
7.1	Menu overview	29
7.2	Menu explanation	30
8	PROGRAMMING AND PARAMETRISATION	31
8.1	Programming	31
8.2	Parametrising scenarios	33
8.2.1	Settings for flow monitoring.....	33
8.2.2	Settings for consumption quantity monitoring.....	34
8.2.3	Settings for temperature monitoring	36
8.2.4	User settings (optional)	37
8.2.5	Service functions	39
8.2.6	Pulse setting	40
8.2.7	Hysteresis function	41
8.2.8	Window function	41
8.2.9	Scaling the measuring range	42
9	REPAIR	43
9.1	Error messages.....	43
9.2	Cleaning the sensor.....	43
9.2.1	Cleaning agents	43
9.3	Recalibration.....	44
10	TROUBLESHOOTING	45
10.1	Replacing damaged parts	45
10.2	Replacing O-rings and sealing rings.....	45
10.3	Return shipment	45
10.4	Disposal.....	45

1 GENERAL INFORMATION

1.1 Incoming goods inspection, transportation and storage

- **Take note of undamaged packaging!**
Communicate damages to the packaging to your supplier. Retain the damaged packaging until the matter is settled.
- **Make sure there is no damaged contents!**
Communicate damages to the contents to your supplier. Retain the damaged goods until the matter is settled.
- **Check the scope of delivery** for completeness by referring to the shipping documents and your order.
- **The instrument is to be packaged for storage and transport in a way that protects it from impacts and moisture.** The original packaging offers optimum protection. The permissible ambient conditions are also to be observed (☞ see 4 Technical data).
- **If you have any questions, please contact your supplier or their sales office.**

2 SAFETY PRECAUTIONS

Read this instruction manual before commissioning the compressed air meter. Store this instruction manual in a location that is accessible for all users at all times.

2.1 Intended use

The compressed air meter is intended exclusively for use in pipe systems for working compressed air, provided that the calibration certificate does not explicitly allow use with other gases.

WARNING



The structural design allows for operation in pressurised systems up to PN 16 (DN 65 bis DN 200) and PN 14 (DN 250)



ATTENTION

Any use other than that described will compromise the safety of persons and the entire measuring system and is therefore not permitted.

The manufacturer shall accept no liability for damages that occur as a result of improper or inappropriate use or installation. To prevent damage to the instruments or health risks occurring the measuring units **must never be manipulated with tools** unless expressly defined in this instruction manual.

The compressed air meter may only be operated under the ambient conditions specified in the technical data. Otherwise, inaccurate measurements will occur and instrument malfunctions cannot be ruled out. To ensure the safety of the user and the functionality of the instruments, the commissioning steps, checks and maintenance work recommended by the manufacturer are to be complied with and carried out.

These instructions do not contain complete detailed information for the sake of transparency. Should you require further information or should a specific problem occur that is not comprehensively handled in the instructions, you can request the required information directly from the manufacturer.

2.2 Installation, commissioning and operation

The compressed air meter was built and tested reliably according to state-of-the-art technology and left the factory in an appropriately safe condition.

2.2.1.1.1 As the user, you are responsible for compliance with all valid safety regulations, including:

- **Installation specifications**
- **Local standards and regulations.**

The manufacturer has undertaken all necessary measures to ensure safe operation. The user must ensure that the instruments are set up and installed in such a way that their safe use is not affected.

This instruction manual contains information and warnings that must be followed by the user in order to ensure safe operation.

- Installation, commissioning, operation and maintenance of the measuring unit may **only be performed by trained, authorised personnel**. The personnel must be authorised for the specified tasks by the system operator.
- **The authorised personnel must have read and understood this instruction manual and comply with the instructions set out in it.**
- Check all connections for correctness before commissioning the complete measuring station.
- **Do not commission damaged products and keep these from being inadvertently commissioned.** Mark the damaged products as defective.
- Faults at the measuring point are only to be corrected by authorised and specially trained personnel.
- If faults cannot be corrected, the products must be taken out of operation and be safeguarded from inadvertent commissioning.
- Repairs that are not described in this instruction manual may only be carried out directly by the manufacturer or by the service organisation.

2.3 Exclusion of liability

Liability of the manufacturer and its vicarious agents shall exist only in the event of deliberate acts or gross negligence. The extent of liability shall be limited to the value of the respective order placed with the manufacturer. The manufacturer shall accept no liability for damages that occur due to non-observance of the safety instructions or non-compliance with the instruction manual or the operating conditions. Consequential damages are excluded from the liability.



Note

**Use the components only in the supplied combination.
Due to the design, they are not necessarily compatible
with older compressed air meters.**

3 DESIGN AND FUNCTION

Overview of components

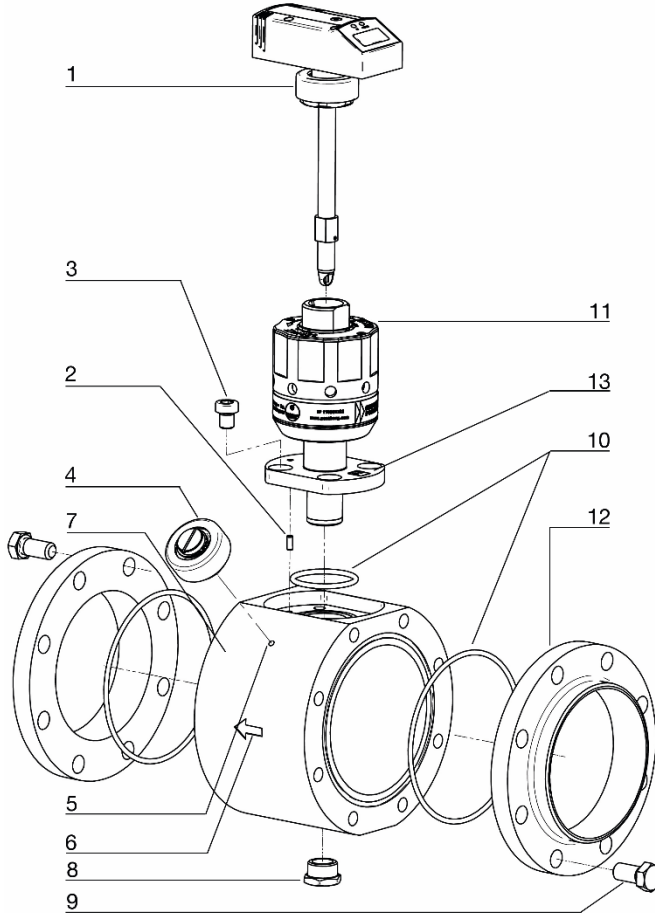

1	Sensor unit	2	Straight pin as alignment aid
3	Hexagon socket head screw M 10	4	Dummy plug
5	Dummy plug holder both sides	6	Direction of flow arrow
7	Measuring station	8	Brass sealing plug
9	Hexagon screw depending on DN	10	Viton O-rings
11	Aluminium interchangeable fitting	12	Welding neck flange
13	Flange		

The equipment is supplied loosely pre-assembled in 3 parts: sensor, interchangeable fitting and station. Also included in the scope of delivery:

- Calibration certificate in compliance with ISO/IEC 17025

3.1 Electric sensor unit interchangeable fitting

The sensor records the standard volumetric flow of the working compressed air according to the calorimetric measurement principle. The standard volumetric flow is calculated on the basis of DIN ISO 2533 (1013.25 mbar, 15 °C and 0% relative humidity), unless otherwise stated on the calibration certificate. The relevant unit is Nm³/h or NI/min.

Observe the general operating conditions for compressed air systems. The air quality of the working compressed air influences the measuring accuracy as follows:

Quality classes according to ISO 8573-1 particle/humidity/oil	Measurment
1-4-1	± (3% of reading + 0.3% of final value of measuring range)
3-4-4	± (6% of reading + 0.6% of final value of measuring range)

Measuring signals

The instrument shows the current process values on a display. It generates 2 output signals according to the parametrization.

- Current flow rate
- Current consumption quantity (pulse output module and totaliser)

Display

- Current volume flow in Nm³/h or NI/min
- Current consumption quantity in Nm³
- Current average speed in Nm/s
- Current media temperature in °C
- Switching states of the respective outputs

Sensor output 1

- Switch signal as the limit value for volume flow or flow velocity, hysteresis or window function as N/O or N/C contact.
- Quantity monitoring using the preset counter.

Sensor output 2

- Switch signal as the limit value for volume flow, flow velocity or temperature, hysteresis or window function as N/O or N/C contact.
- Analogue signal (4-20 mA) for volume flow, flow velocity or temperature.

Relative measuring range (%)

Measuring range	Recording/ display range
0.33% (0.4%) - 100%	0% to 120%

The absolute measuring range depends on the nominal width (see following table).

Absolute measuring range



WARNING

The compressed air meter may be used to measure the volume flow of **working compressed air with up to 16 bar (DN 65 to DN 200) or 14 bar (DN 250) overpressure.**

Nominal width	Measuring range	Recording/ display range
DN 65	6.7-2,000 m ³ /h	0.11-2,400 m ³ /h
DN 80	9.2-2,750 m ³ /h	0.15-3,300 m ³ /h
DN 100	15-4,400 m ³ /h	0.24-5,280 m ³ /h
DN 125	23-7,000 m ³ /h	0.39-8,400 m ³ /h
DN 150	33-10,000 m ³ /h	0.55-12,000 m ³ /h
DN 200	58-17,500 m ³ /h	0.97-21,000 m ³ /h
DN 250	92-27,500 m ³ /h	1.53-33,000 m ³ /h

Specifications according to DIN ISO 2533 (15 °C, 1013 mbar and 0% rel. humidity).

3.2 Interchangeable fitting with Compac flange

The patented aluminium interchangeable fitting accommodates the sensor unit as an applicator and, thanks to its mechanics, enables precisely reproducible positioning and measurement with the highest measuring accuracy.

A sensor change for maintenance or exchange can take place any time **without interrupting the flow**. For pipe cleaning purposes, e.g. rinsing or sandblasting, the sensor can be retracted and thus remains protected without removal (end position service).

Please note the following design details for correct positioning of the components after welding in the pipeline according to the direction of flow:

The upper cap of the interchangeable fitting is provided by a sealing cone. This is designed with a slot that only receives the sensor pin in the downstream direction of flow.

The Compac flange in the lower section makes up the intersection between the interchangeable fitting and measuring station. The straight pin of the measuring station engages in the one-sided bore of the Compac flange.

3.3 Compac welding neck flange (V flange) steel

The connection between the measuring point interface and the pipe system is made by the Compac welding neck flange. These seal twice – both metal-wise and against an O-ring made of Viton in a circumferential groove in the measuring station. The advantages of these flanges in comparison to standard DIN flanges with flat seals are the significantly smaller construction volume and thus material volume and weight, lower bolt tightening forces and the prevention of overstraining of the seal (with regard to deformation and compression) – with higher density efficiency and leakage reliability. **Slight scratches in the contact surfaces are tolerated without loss of function due to the high compressive force.**

Example: DN 250 at PN 100

- Compac flange weight 15 kg
- Previous flange weight 81 kg



Note

To avoid a mixed seam in the welded connection to the pipeline, make sure that the Compac flanges are made of steel or stainless steel according to the pipeline.

An alternative to the welding neck flange (V flange) is to fit a Compac threaded flange (G flange).

Sealing principle of the Compac flange

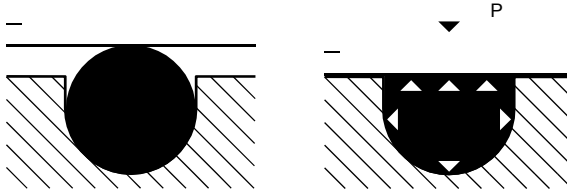

3.4 Dummy plug included as standard

The dummy plug is made of stainless steel and has a bright red plastic protective cap to stop it unintentionally loosening.

It secures the measuring point interface while the sensor is uninstalled, e.g. when changing the sensor for recalibration. For this purpose, it is screwed onto the sealing cone (Fig. 1) **when the interchangeable fitting is closed (service position)**.

The dummy plug seals both metal-wise and redundantly via an O-ring. A significant advantage over conventional dummy plugs is that the trapped compressed air can escape safely under pressure during (unintentional) disassembly. When turning the union nut, enough thread turns remain to prevent it "shooting off". If the sensor is installed, the dummy plug is stored near the device in one of the **holders** (tapped bore) – as shown in Figure 2.



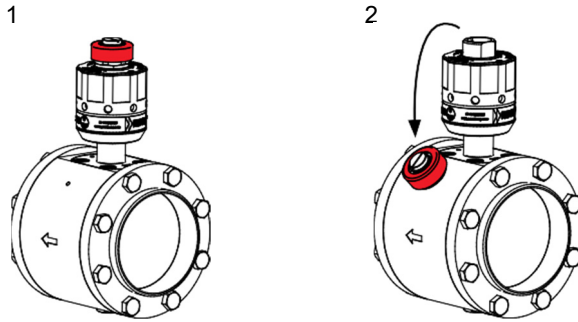

3.5 Measuring station

The measuring station with Compac welding neck flanges is used to precision-mount the electronic volume flow sensor. The measuring station is welded into the pipelines with the Compac welding neck flanges in line with the flow direction (see engraved direction arrow). **The nominal width of the measuring station and welding neck flange must match the nominal pipe width** (☞ see 3). To prevent a mixed seam during welding, the material of the parts must also be the same.

The compressed air meter is designed for all **nominal pipe widths from DN 65 to DN 250**.

3.6 ISO calibration points

The compressed air meter is supplied calibrated to its nominal width. A minimum of six measuring points are parametrised with specified nominal widths, standard temperatures and pressures, then moved to the test stand where the standard volume is tested. The calibration certificate in compliance with ISO/IEC 17025 is included in the scope of delivery.

4 TECHNICAL DATA

4.1 Thermal mass flow sensor

The thermal mass flow sensor for the compressed air volume flow measurement is independent of the process pressure and the media temperature.

Sensor	Thermal glass-coated ceramic sensor
Media	Compressed air
Accuracy	For compressed air quality classes (ISO 8573: particles to humidity to oil) 1:4:1: $\pm 3\%$ of reading, $\pm 0.3\%$ of final value for compressed air quality classes (ISO 8573) 3:4:4: $\pm 6\%$ of reading, $\pm 0,6\%$ of final value
Temperature monitoring	$\pm 2\text{ }^{\circ}\text{C}$
Reproducibility	$\pm 1.5\%$ of reading
Display, operation	4-digit, alphanumeric display, two operating buttons, user menu, operating menu, 5 x green LED (measurement units), 1 x green LED (function display 10 ₃), 2 x yellow LED (switching status)
Display units*	l/min, Nm ³ /h, Nm ³ /s, Nm ³ , $^{\circ}\text{C}$
Measuring dynamics	1:300
Response time	< 0.1 s
Pressure-tight	up to 16 bar (DN 250 to 14 bar)
Media temperature	0 to + 60 $^{\circ}\text{C}$ (rel. humidity max. 90%)
Perm. ambient temp.	0 to + 60 $^{\circ}\text{C}$
Perm. storage temp.	-20 to + 85 $^{\circ}\text{C}$
Media contact	V2A (1.4301) or galvanised steel, glass-coated ceramic, PEEK, polyester, Viton, anodised aluminium
Housing materials	PBT-GF 20, PC (APEC), Makrolon, V2A (1.4301) or galvanised steel, Viton
Protection class	IP65 / III
Electrical connection	M12 x 1 connector, can be loaded to 250 mA, short-circuit-proof
Power supply	19 to 30 VDC, voltage supply < 100 mA
Readiness delay	1 s



Note

Based on the small size, the sensor only has a small contact surface. The pressure loss is thus negligible (typically 1 mbar).

* The measurement, display and adjustment ranges are related to the standard volume flow according to DIN ISO 2533 (15 $^{\circ}\text{C}$, 1013 mbar and 0% rel. humidity) if not otherwise stated in the calibration protocol of the sensor.

Output signals

Analog output	4-20 mA, measuring range scaleable max. load 500 Ω
Pulse output	DN 65-DN 80: 1 pulse/1 Nm ³ DN 100-DN 250: 1 pulse/10 Nm ³
Current carrying capacity	2 x 250 mA, short-circuit-proof, protected against polarity reversal, overload-proof

EMC

IEC 1000/4/2 ESD	4/8 kV
IEC 1000/4/3 HF radiated	10 V/m
IEC 1000/4/4 burst	2 kV
IEC 1000/4/6 HF grid-bound	10 V

4.2 Accessories

4.2.1 Connecting cable with electric isolation

A connecting cable with an electrical isolator integrated into the connector is available as an accessory. The cable is 5 metres long and is used for the galvanic isolation of the sensor output to the electronics to which it is attached. The cable is delivered with an appropriate connector for the mass flow sensor on one side and with open cable ends on the other side.

4.2.2 Replacement sensor

The replacement sensor serves as a replacement in case of damage to or loss of the original mass flow sensor.



Note

When ordering a new sensor, please indicate the certificate number of the old sensor in order to take account of customer-specific measuring conditions directly during calibration.

4.2.3 Calibration options

ISO certificate

An ISO certificate from the manufacturer documents six measuring points including the measuring conditions.

5 INSTALLATION



WARNING

Installation may only be carried out by authorised, qualified staff, e.g. pipeline engineers. Please observe the relevant national regulations. The electrical connections are to be performed by a qualified electrician.



WARNING

To install and remove the sensor the line must be depressurized. Ensure that the line section cannot be inadvertently used (lockout-tagout).

5.1 Determining the place of installation

Please always observe the technical data (☞ see 4.1). The place of installation is to meet the following criteria:

- **Medium does not condense at the place of installation, i.e. measuring location only behind a suitable compressed air dryer**, which ensures an appropriate pressure dew point. Otherwise the specified measuring accuracy cannot be guaranteed.
- **Ambient temperature of maximum + 60 °C** (note any potential thermal radiation).
- **Take account of the inflow and outflow section** (☞ see 5.4).
- **Take account of the direction of flow** (☞ see 5.5).
- **Well accessible with low vibration.**
- **A min. 600 mm space is needed** to remove the sensor.

5.2 Length measurements of the compressed air meter

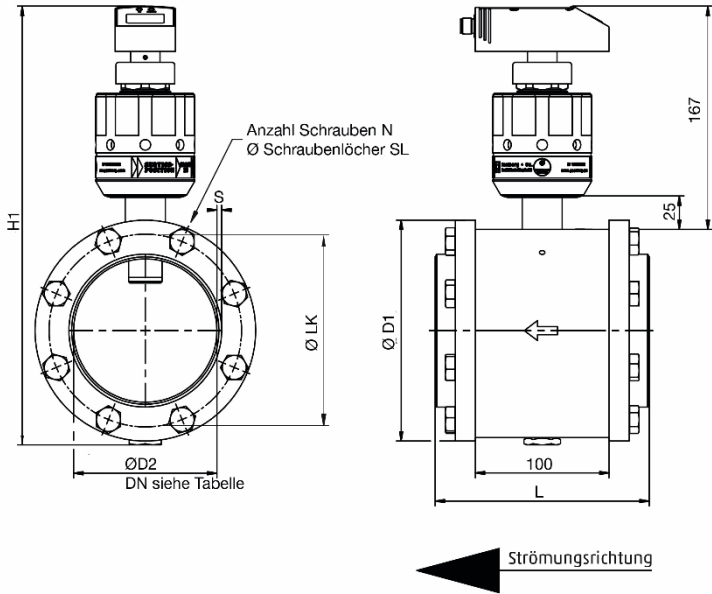

Inch	DN	L	Ø D1	Ø D2	S	H1	N	SL	LK
		mm	mm	mm	mm	mm		mm	mm
2½"	65	148	125	70.3	2.9	288	8	13	106
3"	80	160	141	82.5	3.2	302	8	13	118
4"	100	160	165	107.1	3.6	328	8	13	144
5"	125	172	205	131.7	4	360	12	13	168
6"	150	180	235	159.3	4.5	388	8	17	200
8"	200	180	290	207.3	5.9	440	12	17	252
10"	250	196	355	260.4	6.3	500	12	21	315

5.3 Installation position

Do not install the sensor in the crossed-out installation positions shown in the following graphic in point 6. Otherwise, in the event of a limited flow rate, the specified accuracy cannot be maintained.

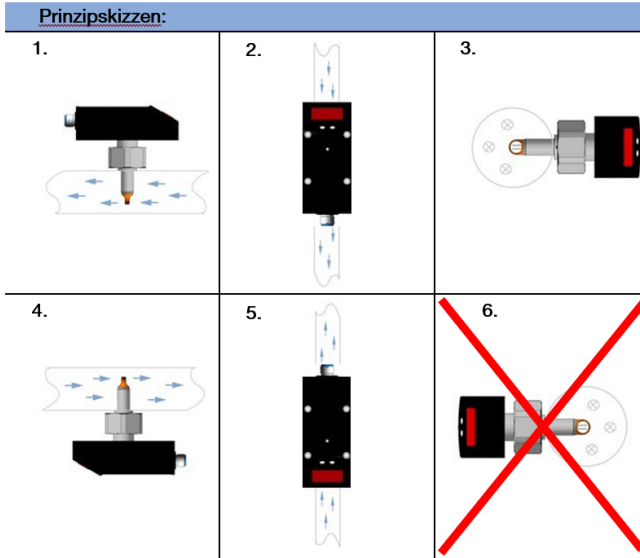

The arrow shows the direction of flow for the medium.

- 1: Vertical installation position, direction of flow horizontally to the left, probe downwards
- 2: Horizontal installation position, direction of flow vertically downwards, probe to the rear
- 3: Horizontal installation position, direction of flow horizontally to the rear, probe to the left (heated sensor element upwards)
- 4: Vertical installation position, direction of flow horizontally to the right, probe upwards
- 5: Horizontal installation position, direction of flow vertically upwards, probe to the rear
- ~~6~~: Horizontal installation position, direction of flow horizontally to the rear, probe to the right (heated sensor element downwards, problems possible at low flow rates)

5.4 Required measuring section



Note

Take account of the required **inflow and outflow section** in order to achieve the specified measuring accuracy. The inflow section refers to the pipeline length **upstream** of the compressed air meter and the outflow section to the pipeline length **downstream** of the compressed air meter, as seen in the direction of flow for the medium.





Total measurement section = inflow section + outflow section

Outflow section = 5 x D

Inflow route = 15 x D + B

D = pipe diameter [mm]

B = additional calming section

	Changes to the pipe diameter	B = 5 x pipe diameter
	90° elbow	B = 5 x pipe diameter
	Two 90° elbows, one level	B = 10 x pipe diameter
	Two 90° elbows, two levels	B = 15 x pipe diameter
	Valve, slider	B = 35 x pipe diameter

5.5 Direction of flow



Note

Take the direction of flow into account when installing the measuring station. This is indicated by the arrow engraved on the side of the measuring station. The arrow points in the direction that the medium flows in the pipeline.

5.6 Installation of the compressed air meter



Note

To avoid a mixed seam in the welded connection to the pipeline, make sure that the Compac flanges are made of steel or stainless steel according to the pipeline.



WARNING

To install and remove the compressed air meter the line must be depressurized. Ensure that the line section cannot be inadvertently used (lockout-tagout).



WARNING

A stable stepladder is required for all assembly work carried out up to 2.5 metres off the floor (height of the pipe). A working platform must be provided for work at greater heights. If the measuring point cannot be accessed by a platform, then scaffolding or other equipment must be used to provide a safe working platform.

5.6.1 Installation of the measuring station

1. Depressurize the pipe section at the installation point and secure it against accidental reconnection (lockout-tagout).
2. Weld the Compac welding neck flange to the existing pipeline **with no torsion, taking national regulations into account**, to achieve optimal tightness.



Note

Make sure that the measuring station is installed in the direction of flow – see arrow. Otherwise, there may be sensor measuring inaccuracies.

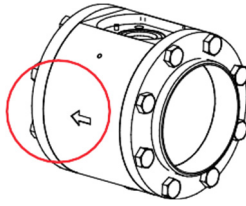

3. Screw the measuring station between the flanges according to the direction of flow. Fix the screws in diagonal order for even force distribution.

5.6.2 Installing the sensor in the measuring station



WARNING

Make sure that the pipeline is depressurized before installing the compressed air meter for the first time.

1. After installing the measuring station in the depressurized pipeline, screw the interchangeable fitting on the Compac flange with seal onto the station.
2. To install the sensor unscrew the dummy plug from the sealing cone and temporarily store it in the holder on the side of the measuring station.
3. Remove the red protective transportation cap from the tip of the sensor and keep it for the next time you remove the sensor.

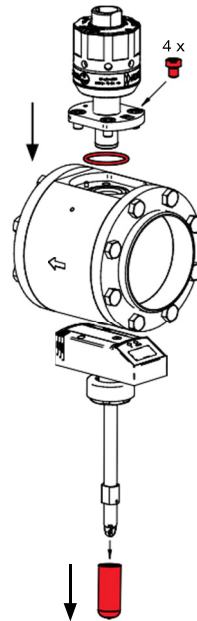

4. **Mount the sensor in the sealing cone of the closed interchangeable fitting – service end position. Take notice of the correct installation position of the sensor.** Due to the design, the sensor can only be screwed onto the sealing cone in one direction (bolt/groove principle). The head of the sensor, i.e. the display, points in the direction of the inflow.

If this is not the case, the measuring station has to be turned between the flanges.

5. Fix the sensor to the interchangeable fitting with the union nut **and without tools**.

6. The mechanical installation of the compressed air meter is now complete.

7. **Move the sensor to the end position by turning the interchangeable fitting manually.** The measuring window is thus positioned open in the nominal width of the corresponding height in the pipe and the measurement can be started after the electrical connection is established.

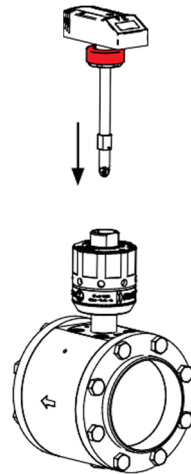

5.7 Sensor replacement

Removal of the mounted sensor may be necessary for maintenance, cleaning and calibration purposes or for mobile sensor use.



WARNING

Never remove the sensor or the dummy plug from the sealing cone of the interchangeable fitting when the line is under pressure and the interchangeable fitting is in the measuring end position – *this may be life-threatening!*

1. **Turn the interchangeable fitting manually to the service end position.**
2. Remove the electric connecting cable by unscrewing the connector from the sensor by hand. Protect the connector from contamination and moisture.
3. Remove the sensor **without tools** from the interchangeable fitting pulling it up and out vertically.
4. Mount the dummy plug (☞ see 3.2) on the sealing cone of the interchangeable fitting.
5. **Protect the sensor tip with the red protective transportation cap.**

5.8 Electrical connection

Disconnect the system from the power supply when connecting.



The instrument may **only be installed by a qualified electrician**. Follow the national and international regulations regarding the installation of electrical engineering systems. The voltage supply is to be laid out in accordance with EN50178, SELV, and PELV. To meet the "limited voltage" requirements according to UL 508, the instrument must be supplied from a galvanically isolated source and protected by an overcurrent device.

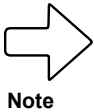

If you are connecting the sensor directly or using a **4-wire connecting cable**, **proceed as set out in 5.8.1**.

If you are using the optionally available **5-wire connecting cable** with potential-free pulse output ( see 4.2.2), **proceed as set out in 5.8.2 when connecting the sensor**.

5.8.1 4-wire pin assignment

If you use the standard connection, the following pin assignment applies to the connecting cable or the pin assignment directly on the sensor.

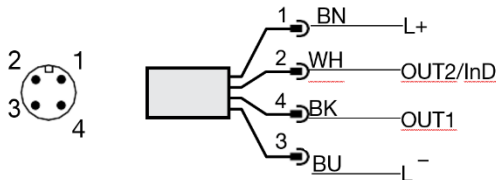

Pin no.	Wire colour	Assignment
1	Brown	+L (19-30 V DC)
2	White	OUT2/InD
3	Blue	0 V DC (GND)
4	Black	OUT1

5.8.1.1 1 x pulse output, 1 x analog output (condition on delivery)

The OUT1 output is used as a PNP signal output (pulse) and the OUT2 output is used as an analog output. This is the configuration in which the sensors are delivered.

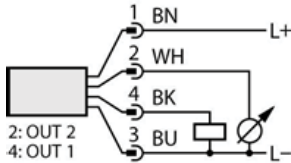

Pin = designation (wire colour)
 1= BN (brown)
 2= WH (white)
 3 = BU (blue)
 4 = BK (black)

5.8.1.2 2 x pulse output

Both of the available OUT1 and OUT2 outputs are each used as a PNP signal output (pulse).

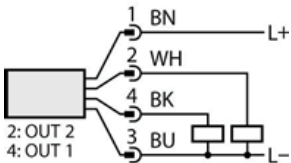

5.8.2 5-wire pin assignment (accessory)

If the optional connecting cable for electrical isolation is used (see 4.2.2), then the following assignments apply.

Pin no.	Wire colour	Assignment
1	Brown	+L (19 to 30 V DC) sensor supply
2	Pink	+ potential-free pulse output (collector) OUT1
3	White	- potential-free pulse output (emitter) OUT1
4	Green	OUT2
5	Black	0 V DC (GND)

The potential-free pulse output OUT1 is specified for this connecting cable as follows:

Line type	LIYCY
Length	5 m
Switching capacity	500 mA
Max. switching voltage	36 V
Min. switching voltage	5 V
Switch contact resistance	0.21 Ω
insulation voltage	5.3 kV
Protected against polarity reversal	Yes

6 OPERATION

Thermal mass flow sensor

Familiarise yourself with the operation and programming of the sensor. The sensor is calibrated ex factory and provided with default settings for each nominal width.

6.1 Controls and indicators

The following illustration shows the control and display unit of the sensor from above.

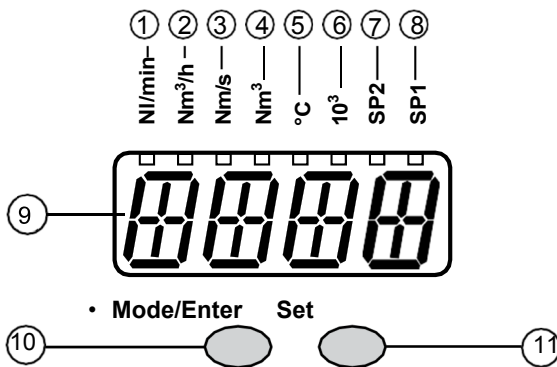

Type	Description
① to ⑧ LED ① LED ② LED ③ LED ④ LED ④ flashing LED ④ and ⑥ LED ④ and ⑥ flashing LED ⑥ LED ⑤ LED ⑦ SP2 LED ⑧ SP1	Illuminated LED = display unit set Current flow rate (NI/min) When the LED ⑥ lights up, displayed value x 1000 Current flow rate (Nm ³ /h) When the LED ⑥ lights up, displayed value x 1000 Current flow velocity (Nm/s) Current consumption quantity since last reset (Nm ³) Consumption quantity before the last reset in (Nm ³) Current consumption quantity since last reset in 10 ³ (Nm ³) (Values > 9999 are displayed in 10 ³ exponential mode) Consumption quantity before last reset in 10 ³ (Nm ³) (Values > 9999 are displayed in 10 ³ exponential mode) = 10 ³ exponential mode Current media temperature in °C Switching status of the respective output (LED also indicates the status of the input during an active external reset) Switching status of the respective output
⑨ 4-digit alphanumeric display	<ul style="list-style-type: none"> • Display of the current volume flow (for setting Uni = Lmin or nm3h and SEld = FLOW) • Display of the current flow velocity (for setting Uni = nmS and SEld = FLOW) • Display of the meter reading (for setting SEld = TOTL) • Display of the current media temperature (for setting SEld = TEMP) • Display of the parameters and parameter values
⑩ Button Mode/Enter	Selection of the parameters and confirmation of the parameter values
⑪ Programming button Set	<ul style="list-style-type: none"> • Setting the parameter values • Changing the display unit in run mode

6.2 Types of operation

6.2.1 Run mode

After switching on the supply voltage, the instrument is in **run mode**. It carries out its measurement and evaluation functions and provides output signals according to the set parameters.

The display shows the current measurement values and the yellow LEDs show the switch status of the outputs.

The display unit may be changed temporarily. For this purpose, press the **Set** button briefly. After 15 seconds, the instrument returns to the display unit that was set in the **Uni** menu item.

The totaliser (consumption quantity counter) stores interim values every 10 minutes as well as the amount of time elapsed of the automatic reset. After a drop in voltage, this value is available as the current status of the totaliser (the possible loss of data can amount to a maximum of 10 minutes).

6.2.2 Display mode

Display of the parameters and set parameter values.

The instrument is switched to **display mode** by briefly pressing **Mode/Enter**. Internally, it remains operational.

The set parameter values can be read independently of this:

- To scroll through the parameters briefly press the **Mode/Enter** button.
- The corresponding parameter value is displayed for approximately 15 seconds by briefly pressing the **Set** button. After a further 15 seconds, the instrument returns to run mode.

6.1.2 Programming mode – parameter configuration

The instrument is switched to **programming mode** if a parameter is selected and the **Set** button is pressed for longer than 5 seconds (the parameter value flashes, then is continuously increased). Internally, the instrument also remains operational.

It continues to carry out its monitoring functions with the existing parameters until the alteration is completed.

You can change the parameter value using the **Set** button and confirm by pressing the **Mode/Enter** button.

The instrument returns to measurement mode if no buttons are pressed for 15 seconds afterwards.

7 MENU

7.1 Menu overview

In the menu overview, (S) indicates the **Set** button and (M) the **Mode** button on the sensor.

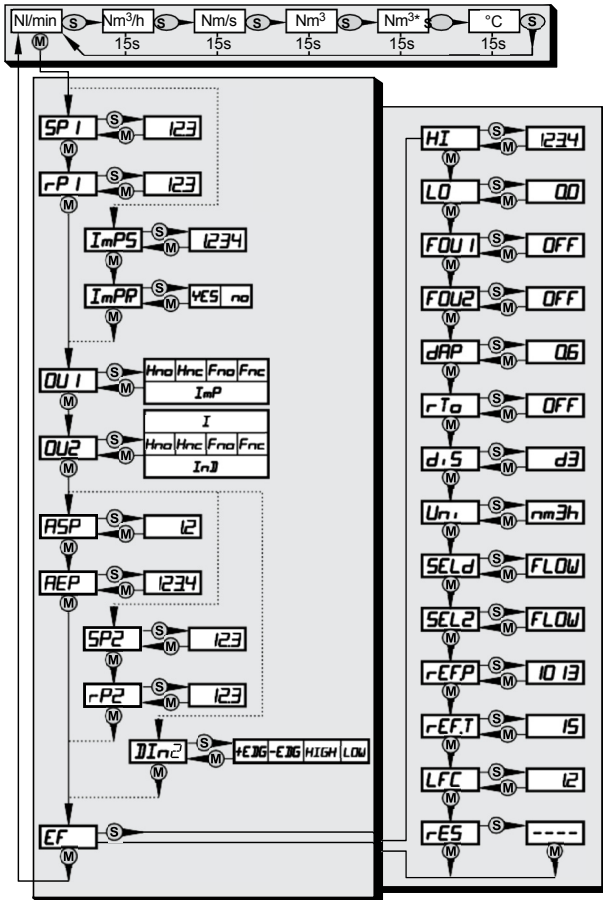

(Nm³)* = volume flow amount before the last reset

The parameter values given in digits represent factory settings or random examples.

7.2 Menu explanation

SP1/rP1	Switch point or Return switch point Upper/lower limit value for flow rate
ImPS	Pulse value
ImPR	Repeat pulse yes = active = pulse output or no = not active = preset counter function
OU1	Initial function for OUT1 (flow rate or consumption quantity): - Switching signal for limit values: Hysteresis function Hno and Hnc or window function Fno and Fnc o = normally open = N/O contact; c = normally closed = N/C contact - Pulse or switching signal for quantity counter
OU2	Initial function for OUT2 (flow rate or temperature): - Switching signal for limit values: Hysteresis function or window function, N/O contact or N/C contact respectively - Analogue signal: 4-20 mA [I] Alternatively: Configure OUT2 (pin 2) as an input for an external reset signal: Setting: OU2 = InD
SP2/rP2	Switch point or return switch point Upper/lower limit value for flow rate or temperature SP2 and rP2 are only active when OU2 = Hno, Hnc, Fno or Fnc
ASP/AEP	Analogue starting value/Analogue end value for flow rate or temperature
DIn2	Configuration of the input (pin 2) for counter reset
EF	Extended Functions/opens menu level 2
HI/LO	Maximum value memory/minimum value memory for flow rate
FOU1	Behaviour of output 1 in the event of an internal error
FOU2	Behaviour of output 2 in the event of an internal error
dAP	Measuring value damping/damping constant in seconds
rTo	Counter reset: manual reset/time-controlled reset
diS	Updating rate and orientation of display
Uni	Standard unit of measurement for flow rate: NI/min, Nm ³ /h or Nm/s
SELd	Standard display measurement parameter: Flow value, meter reading or media temperature

SEL2	Standard measurement parameter for evaluation using OUT2 : - Limit value signal or analogue signal for flow rate - Limit value signal or analogue signal for temperature
rEF.P	Standard pressure measurement and display values refer to for the flow rate
rEF.T	Standard temperature measurement and display values refer to for flow rate
LFC	Low flow cut-off
rES	Reset – reset to factory settings

8 PROGRAMMING AND PARAMETRISATION

8.1 Programming

Each parameter setting requires 3 steps: select parameter – set value – confirm

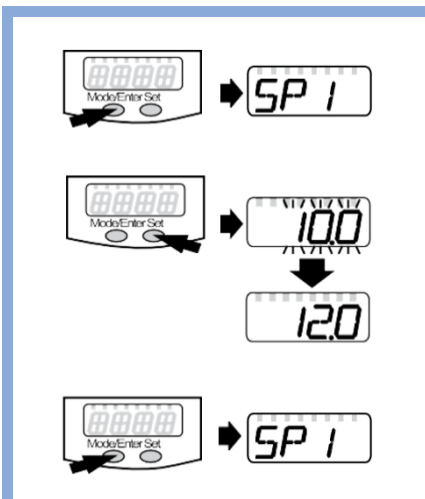

Press the **Mode/Enter** button until the **required parameter** appears on the display.

Press and hold the **Set** button. The current **parameter value flashes for 5 seconds**.

It is then increased* (in increments by pressing once or continuously by pressing and holding the button). Press the **Mode/Enter** button briefly (= confirmation). The parameter is displayed again and the new **parameter value is applied**.

Changing further parameters:

Start again with step 1.

Ending programming:

Wait for 15 seconds or press the **Mode/Enter** button until the current measuring value appears again.

***To reduce the value:**

Allow the display to run through to the maximum setting value. After this, the run-through starts again from the minimum setting value. Set the display unit **Uni** before you set the values for the **SPx**, **rPx**, **ASP** and **AEP** parameters. In this way, rounding up/down errors are avoided during the internal conversion into other units and the exact values required are provided.

Condition at delivery: **Uni = nm3h**.

If no button is pressed for 15 seconds during the configuration process, the instrument returns to run mode with unchanged values.

Switching from menu level 1 to level 2

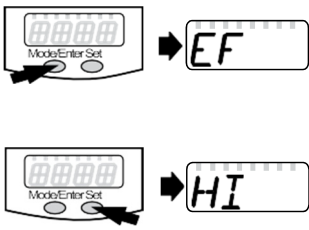

Press the **Mode/Enter** button until **EF** is displayed.
Briefly press **Set**.
The first parameter of the submenu is displayed: **HI**.

Locking – unlocking

To prevent unintentional wrong entries the instrument can be electronically locked. **Condition at delivery: Not locked.**

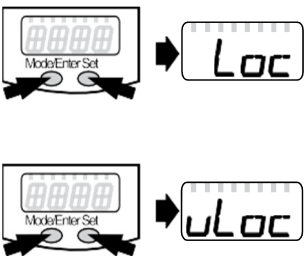

Make sure that the instrument is in normal work mode.
Press **Mode/Enter + Set** for 10 seconds.
Loc is displayed.
During operation, **Loc** is briefly displayed, if you try to change the parameter values.
To unlock: Press **Mode/Enter + Set** for 10 seconds. **uLoc** is displayed.

8.2 Parametrising scenarios

8.2.1 Settings for flow monitoring

8.2.1.1 Configuring limit monitoring with OUT1

Uni	select and specify unit of measurement (☞ see 8.2.4).
OU1	select and set the switching function. Hno = hysteresis function/NO contact Hnc = hysteresis function/NC contact Fno = window function/NO contact Fnc = window function/NC contact
SP1	select and set value with which the output switches.
rP1	select and set value with which the output switches back.

8.2.1.2 Configuring limit monitoring with OUT2

Uni	select and specify unit of measurement (☞ see 8.2.4).
SEL2 FLOW OU2	select and set. select and set the switching function. Hno = hysteresis function/NO contact Hnc = hysteresis function/NC contact Fno = window function/NO contact Fnc = window function/NC contact
SP2	select and set value with which the output switches.
rP2	select and set value with which the output switches back.

8.2.1.3 Configuring the analogue value for flow rate

Uni	select and specify unit of measurement ( see 8.2.4).
SEL2 FLOW OU2	select and set. select and set the function. I = flow-proportionate current signal (4 to 20 mA)
ASP	select and set value with which the minimum value is output.
AEP	select and set value with which the maximum value is output.

8.2.2 Settings for consumption quantity monitoring

8.2.2.1 Configuring quantity monitoring through pulse output

OU1	select and
ImP	set.
ImPS	select and set the flow volume with which 1 pulse is emitted each time ( see 8.2.6).
ImPR YES	select and set. > Pulse repetition is active. Output 1 emits a counting pulse each time the value set in ImPS is reached.

8.2.2.2 Configuring the quantity monitoring using the preset counter

OU1	select and
ImP	set.
ImPS	select and set the flow volume with which output 1 is activated ( see 8.2.6).
ImPR NO	select and set. > Pulse repetition is not active. The output switches ON when the value set in ImPS is reached. It remains switched until the counter is reset.

8.2.2.3 Configuring program-controlled reset

- rTo** select; continue with a) or b).
- Set** a) reset counter manually
Press until rES.T is displayed, then briefly press **Mode/Enter**.
- Set** b) enter value for time-controlled reset
Press until the required value is displayed (intervals of 1 hour to 8 weeks), then briefly press **Mode/Enter**.
- Set** Press until rES.T is displayed, then briefly press **Mode/Enter**.

8.2.2.4 Deactivating counter reset

- rTo** select and
OFF set.
The counter is reset only after overrun (= factory setting). Overrun: the counter is reset to 0 after the maximum value (9 999 999 Nm³).

8.2.2.5 Configuring counter reset using an external signal

- | | |
|-------------|---|
| OU2 | select and |
| InD | set. |
| Din2 | select and set the reset signal.
HIGH = reset for high signal
LOW = reset for low signal
+EDG = reset for rising flank
-EDG = reset for falling flank |

LED 7 ( see 6.1 Controls and indicators) also indicates the input status during an active external reset.

8.2.3 Settings for temperature monitoring

8.2.3.1 Configuring limit monitoring with OUT2

SEL2 TEMP	select and set.
OU2	select and set the switching function. Hno = hysteresis function/NO contact Hnc = hysteresis function/NC contact Fno = window function/NO contact Fnc = window function/NC contact
SP2	select and set value with which the output switches.
rP2	select and set value with which the output switches back.

8.2.3.1 Configuring the analogue value for temperature

SEL2 TEMP	select and set.
OU2	select and set the function. I = temperature-proportionate current signal (4 to 20 mA)
ASP	select and set value with which the minimum value is output.
AEP	select and set value with which the maximum value is output.

8.2.4 User settings (optional)

8.2.4.1 Specifying the standard unit of measurement for flow rate

Uni select and specify unit of measurement.
Lmin = flow volume per standard litre/minute
nm3h = flow volume per standard cubic metre/hour
nmS = flow velocity per standard metre/second
The setting only affects the flow rate value.
Set the display unit before you set the values for the **SPx**, **rPx**, **ASP** and **AEP** parameters. In this way, rounding up/down errors are avoided during the internal conversion into other units and the exact values required are provided.

8.2.4.2 Configuring the standard display

SELD select and specify standard measurement parameter.
FLOW = display shows current flow rate value in standard unit of measurement
TOTL = display shows current meter reading in Nm³ or 1000 Nm³
TEMP = display shows current media temperature in °C

diS select and specify updating rate and orientation of display.
d1 = reading update every 50 ms
d2 = reading update every 200 ms
d3 = reading update every 600 ms
rd1, rd2, rd3 = display as with d1, d2, d3; rotated by 180 °
OFF = display is off in working mode; by pressing the button, the process value appears for 15 seconds.

8.2.3.2 Setting measuring value damping

dAP select and set damping constant in seconds (t value 63%).

8.2.3.3 Configuring the error characteristics of the outputs

FOU1 select and specify value

On = output 1 switches **ON** in the event of an error.

OFF = output 1 switches **OFF** in the event of an error.

> With both values – **ON** and **OFF** – the meter no longer runs in the event of an error.

OU = output 1 switches as defined with the parameters irrespective of any error.

FOU2 select and specify value

On = output 2 switches **ON** in the event of an error; the analogue signal goes to the upper end value (22 mA).

OFF = output 2 switches **OFF** in the event of an error; the analogue signal goes to the lower end value (3.5 mA).

OU = output 2 switches as defined with the parameters irrespective of any error. The course of the analogue signal complies with IEC60947-5-7.

Durchfluss- oder Temperaturüberwachung / Analogfunktion

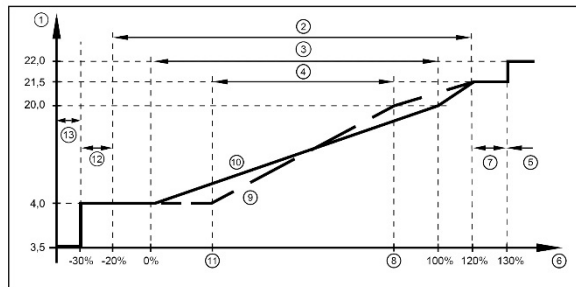

Ausgangskennlinie Analogausgang nach Norm IEC 60947-5-7

- 1: Ausgangsstrom in mA
- 2: Arbeitsbereich
- 3: Messbereich
- 4: Bereich zwischen Analogstartpunkt und Analogendpunkt
- 5: Fehlermeldung [Err.] wird angezeigt
- 6: Messbereichsendwert (MEW)
- 7: Fehlermeldung [OL] wird angezeigt (= overload)

8.2.4.3 Setting the standard pressure which measurement and display values refer to for flow rate

rEF.P select and set the required standard pressure.
Setting range: 950 to 1050 hPa in 1 hPa increments.

8.2.4.4 Setting the standard temperature which measurement and display values refer to for flow rate

rEF.T select and set the required standard temperature.
Setting range: 0 to 25 °C in 1 °C increments.

8.2.4.5 Setting the low flow cut-off

LFC select and set the limit value.
Setting range: 0.1 to 0.8 Nm³/h in 0.1 Nm³/h increments.

8.2.5 Service functions

8.2.5.1 Reading min./max. values for flow rate

HI or select;
LO press briefly.
Set **HI** = maximum value;
LO = minimum value
Deleting memory

HI or select.
LO

Set press and hold it down until [----] is displayed.

Press **Mode/Enter** briefly.
It is a good idea to clear the memory as soon as the instrument is used for the first time under normal working conditions.

8.2.3.4 Resetting all parameters to factory setting



Note

After resetting to factory setting, the memory value is zero.

rES select.

Set press and hold it down until [----] is displayed.

Press **Mode/Enter** briefly.

It is recommended noting down the individual settings before carrying out this function.

8.2.6 Pulse setting

ImPS

Pulse settings in 7 ranges

ImPS is only active when **OU1 = Imp**

	LED	Display	Incremental range	Setting range
1	4	0.001 to 9.999	0.001 Nm ³	0.001 to 9.999 Nm ³
2	4	10.00 to 99.99	0.01 Nm ³	10.00 to 99.99 Nm ³
3	4	100.0 to 999.9	0.1 Nm ³	100.0 to 999.9 Nm ³
4	4	1000 to 9999	1 Nm ³	1000 to 9999 Nm ³
5	4+6	10.00 to 99.99	10 Nm ³	10 000 to 99 990 Nm ³
6	4+6	100.0 to 999.9	100 Nm ³	100 000 to 999 900 Nm ³
7	4+6	1000 to 1000		1 000 000 Nm ³

- Set **OU1** to **ImP**
 - Press **Mode/Enter** until **ImPS** is displayed.
 - Press and hold **Set**.
 - > The current numerical value flashes for 5 seconds, then one of the four digits is active (digit flashes; can be changed).
 - Setting the required pulse value:
 - First select the required setting range (1, 2, 3, etc.): Press and hold the **Set** button until the setting range has the required value.
 - Enter the value from left (first digit) to right (fourth digit).
 - Press **Mode/ Enter** briefly when all 4 digits are set.
- If **Set** is kept pressed down, the display will go through all ranges. When it reaches the final value, it returns to the first one. Release **Set** briefly and begin with the setting again.

8.2.7 Hysteresis function

The hysteresis keeps the switching status of the output stable if the flow rate fluctuates around the nominal value. When the flow rate increases, the output switches upon reaching the switch point **SPx**. If the flow rate decreases again, the output only switches back when the return switch point **rPx** is reached.

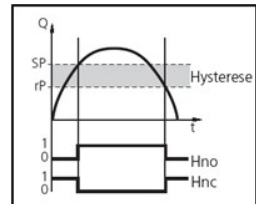

The hysteresis is adjustable:

First the switch point is determined, then the return switch point at the required distance.

8.2.8 Window function

The window function allows a defined OK range to be monitored. If the flow rate moves between switch point **SPx** and return switch point **rPx**, the output is switched through (window function/ N/O contact) or opened (window function/ N/C contact).

The size of the window is adjustable by the distance between SPx and rPx.
SPx = upper value; **rPx** = lower value.

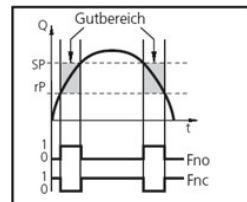

8.2.9 Scaling the measuring range

- With the analog starting point parameter **ASP**, you determine at which measuring value the output signal is 4 mA.
- With the analog end point parameter **AEP**, you determine at which measuring value the output signal is 20 mA.
- Minimum distance between **ASP** and **AEP** = 25% of final value of measuring range

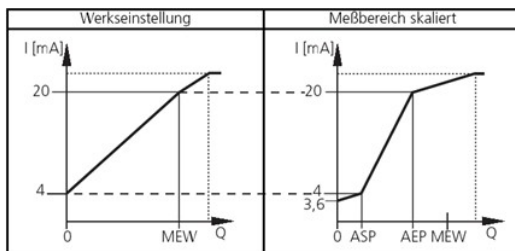

MEW = final value of measuring range

The output signal is between 4 and 20 mA in the set measuring range.

Further signals are:

- Flow rate above the measuring range: output signal > 20 mA
- Flow rate below the measuring range: output signal between 3.6 and 4 mA.

9 REPAIR

9.1 Error messages

Display Description	
UL	Measuring value < -20% of final value of measuring range (temperature)
OL	Recording range exceeded (Flow rate > 120% of final value of measuring range)
SC1	Flashing: short-circuit in switching output 1*
SC2	Flashing: short-circuit in switching output 2*
SC	Flashing: short-circuit in both switching outputs*
Err	Flashing: Malfunction in probe

*The affected output is switched off as long as the short-circuit lasts.



Note

These messages are shown even when the display is off.

9.2 Cleaning the sensor

You must clean the sensor:

- Before each calibration/inspection (at least 1 x per year)
- Regularly during operation.

You can remove the sensor and clean it manually.

9.2.1 Cleaning agents

For cleaning the sensor, use agents containing surfactants (alkaline) or water-soluble organic solvents (e.g. ethanol).

Isopropanol is recommended for cleaning various contamination, especially greases and oils.



ATTENTION

- Clean the sensor **with approved cleaning agents only**.
- Do not use any **chafing (abrasive) cleaning agents**. These can lead to irreparable damages to the sensor.
- **Carry out a new inspection after cleaning, as required.**
- During cleaning, take care not to mechanically stress the sensor plates, as they may break, causing irreparable damage to the sensor. (Rinse the sensor, do not clean mechanically.)
-



Note

The sensor is to be cleaned in an ultrasound bath within 2 minutes. For example, a solution of 99% distilled water with 1% EM-404 from EMAG (aluminium and die-cast cleaner) serves as a cleaning agent. Place the sensor in the mixed solution – the sensor tip must be completely immersed. Switch on the ultrasound unit for 2 minutes. Rinse the sensor tip with pure distilled water and allow it to air dry.

9.3 Recalibration

Due to contamination (e.g. oil, water and particles) and component drift, an annual recalibration of the sensor is recommended. Regular calibrations are essential for cost transparency and correct billing.

10 TROUBLESHOOTING

10.1 Replacing damaged parts



If faults cannot be corrected, the products must be taken out of operation and be safeguarded from inadvertent commissioning. Replace all damaged parts immediately. Damages to the compressed air meter that affect the pressure integrity may **only be remedied by authorised personnel**. After each repair, the technical data of the specifications must be checked by qualified personnel, e.g. by means of a pressure test.

To order spare parts please contact our Service team, either by phone on +49 7653 6810 or email to info@testo.de

10.2 Replacing O-rings and sealing rings

- Keep the sealing surfaces clean.
- Remove any adhered residues from time to time.
- In the event of leakage, contact your supplier.



ATTENTION

Danger of the medium escaping! Replacement of the seals may only be performed by authorised personnel.

10.3 Return shipment

In case of repair, please send the sensor to the supplier in its original packaging.

10.4 Disposal



The sensor design takes environmental compatibility into account in the best way possible. According to the EU directive 2002/96/EC, compressed air meters must be conveyed to a **separate collection point for electrical and electronic devices** or may be sent to the supplier for disposal. They may **not** be added to the unsorted municipal waste.

Please observe the local regulations.

